

Despliegue del triángulo preensamblado y de la subestructura portalastre

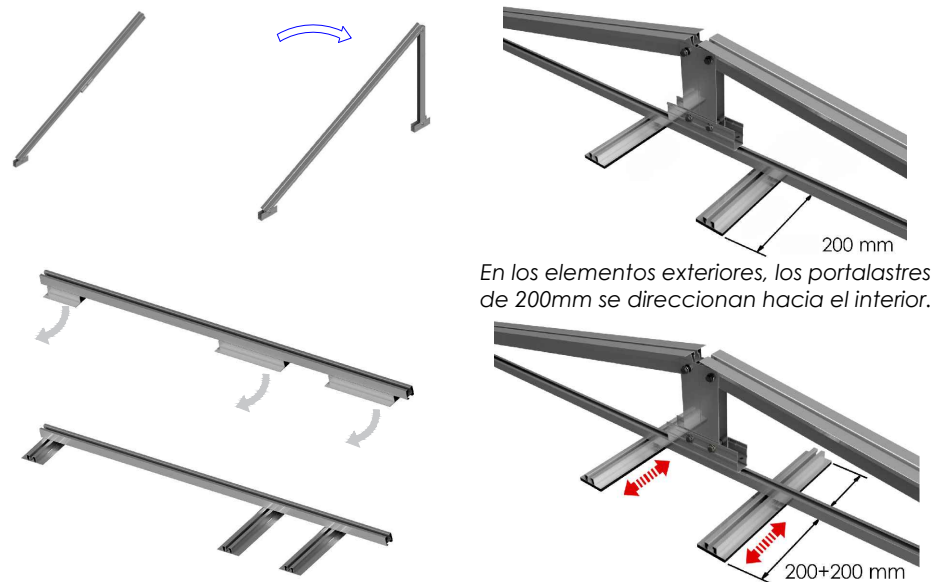

En los elementos exteriores, los portalastres de 200mm se dirigen hacia el interior.

En los elementos interiores, los portalastre de 400mm, se quedan centrados.

Girar los portalastres en función de su posición global en el soporte. (Ver pág. 2)

Anclaje del triángulo a la subestructura y regulación de la separación

¹Base trasera: Aflojar tornillos, retirar tuerca cilíndrica, posicionar triángulo, insertar cilindro y apretar los tornillos.

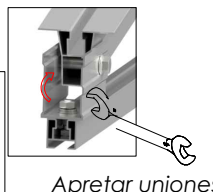
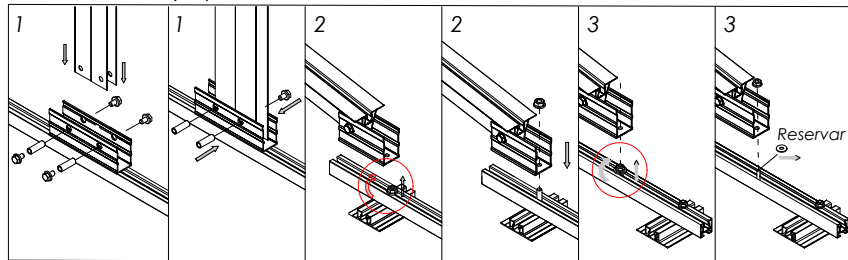

Apretar uniones

²Base delantera: Aflojar la tuerca de la subestructura, separar las arandelas y la tuerca, alinear el orificio del triángulo con el tornillo de la subestructura, bajar triángulo y ensamblar la unión con las arandelas y tuerca. La posición de la base delantera puede regularse.

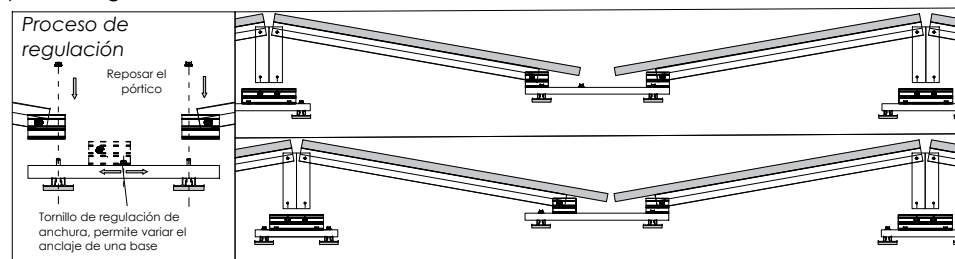

Soporte inclinado lastrado para cubierta plana. Este-Oeste. Horizontal.

26H



Distancias entre pórticos y emplazamiento de contrapeso

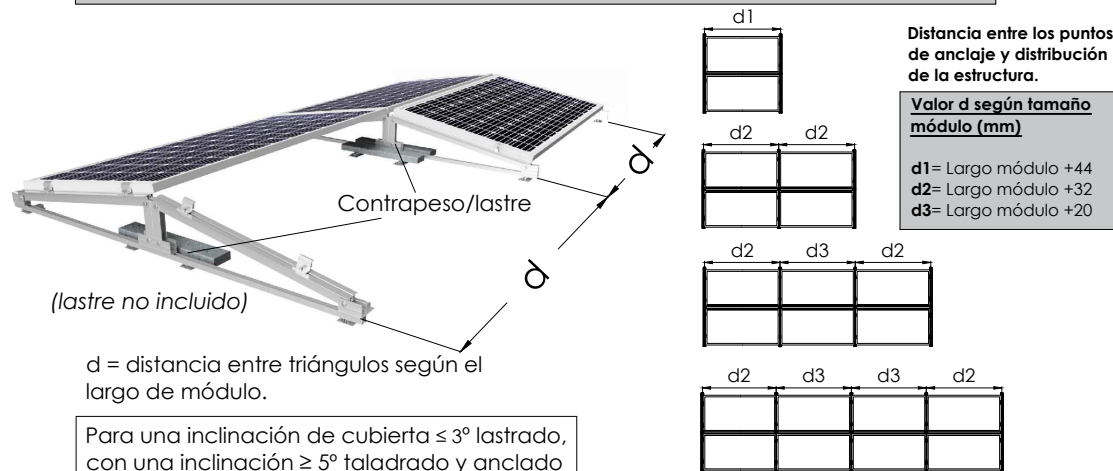

(lastre no incluido)

d = distancia entre triángulos según el largo de módulo.

Para una inclinación de cubierta ≤ 3° lastrado, con una inclinación ≥ 5° taladrado y anclado

Montaje módulos

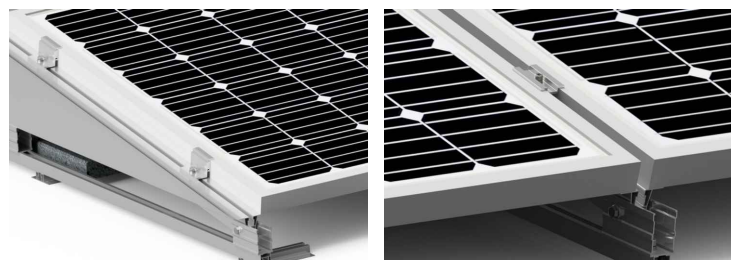

Presor lateral

Presor central

Colocar tapas antiviento



Fijar tapa antiviento al pórtico a través de tornillos autorroscantes suministrados.

Tapa lateral (No incluido en el kit)



4 tornillos de fijación por tapa lateral

PLANO DE MONTAJE

Tamaño máx. 2279x1150



Mercado ES19/86524 CE

Soporte inclinado lastrado para cubierta plana.
Este-Oeste. Horizontal.

26H

SUNFER

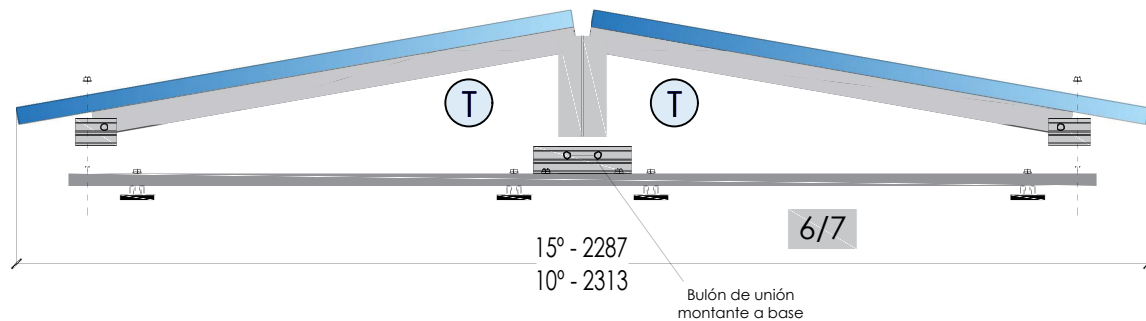

1F2M

CARACTERÍSTICAS DEL MONTAJE

Triángulos
4

Elemento 6
2

S10	Tapa lateral
8	4



*No incluido en el kit

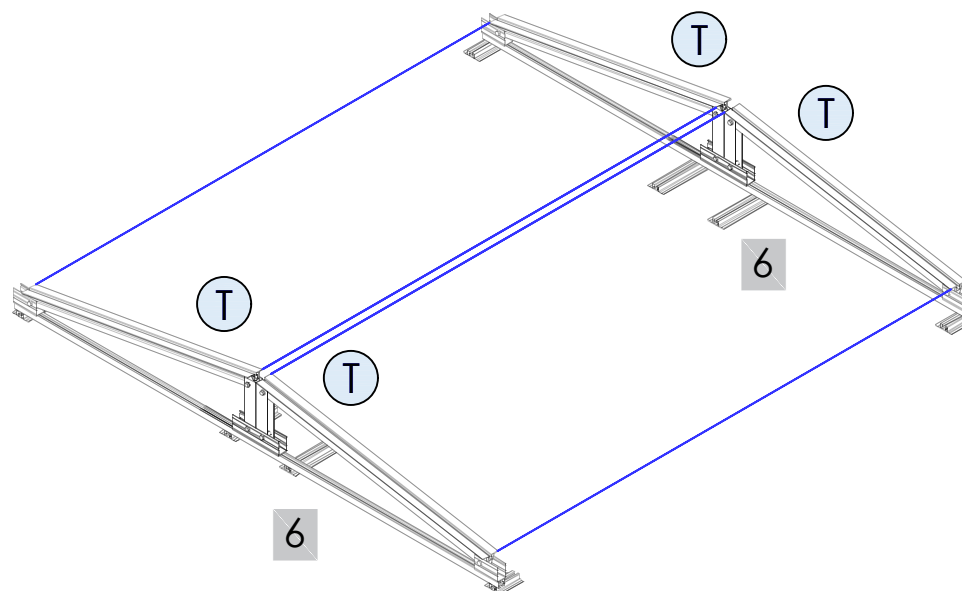

Marcado ES19/86524 CE

2/2

1F2M

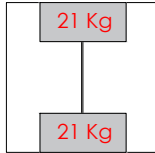

2F4M

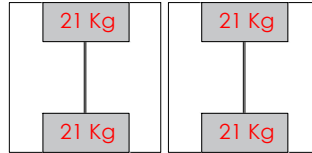

3F6M

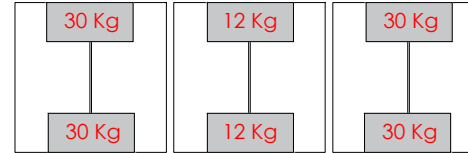

1F4M

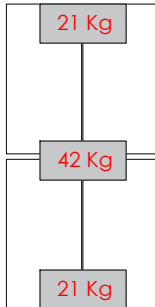

2F8M

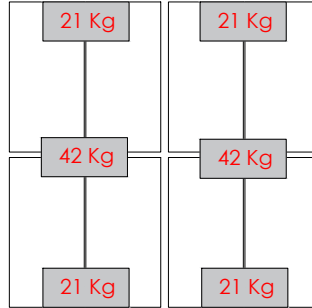

3F12M

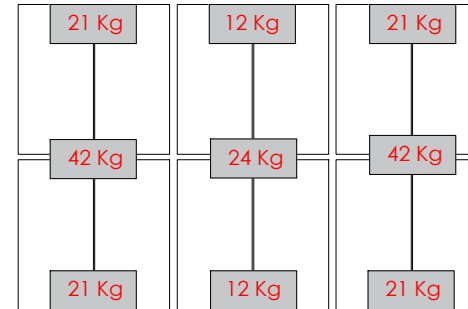

1F6M

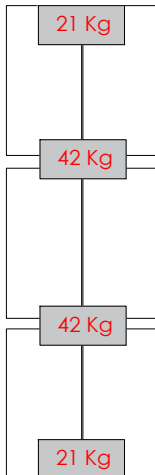

2F12M

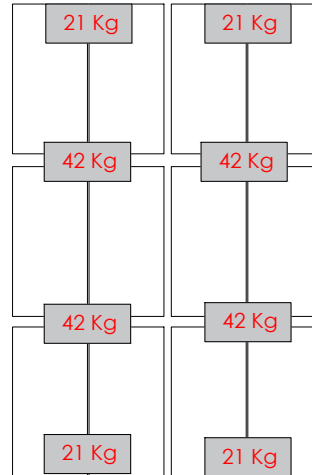

3F18M

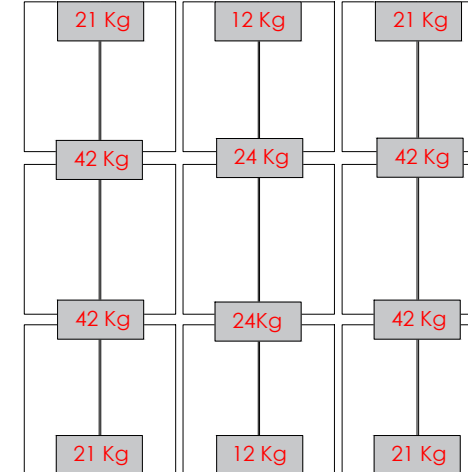

***CON TAPAS LATERALES**

Velocidad: 110 Km/h

Inclinación: 15°

CONTRAPESOS



*Contrapeso necesario para una velocidad de 110Km/h.

*Válido siempre que se mantenga el Kit unido.

*Los lastres del presente plano se han calculado para cubiertas planas de pendiente $\leq 3^\circ$, cuyo coeficiente de rozamiento sea de 0,7.

*La DF deberá comprobar mediante un ensayo in-situ que el coeficiente de fricción es igual o mayor de 0,7. Ver documento "Ensayo de fricción".



1F2M

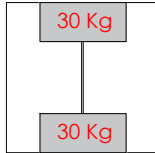

2F4M

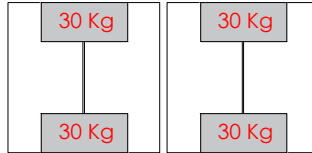

3F6M

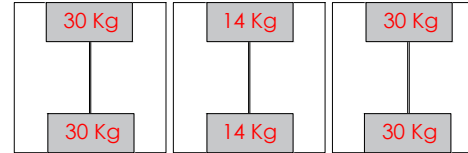

1F4M

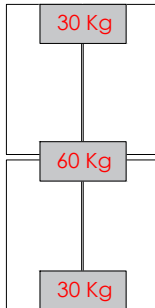

2F8M

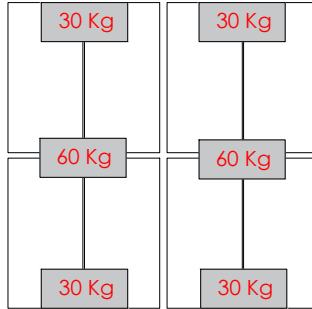

3F12M

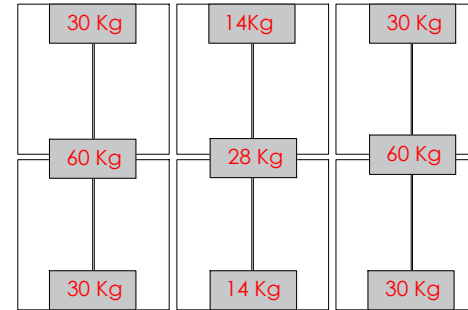

1F6M

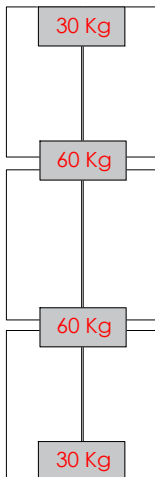

2F12M

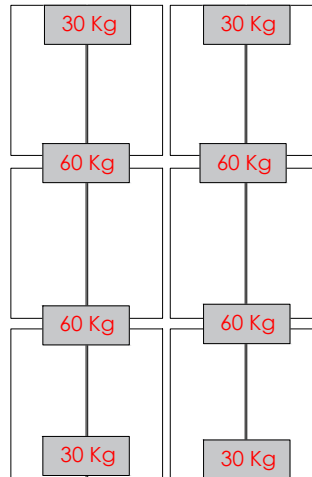

3F18M

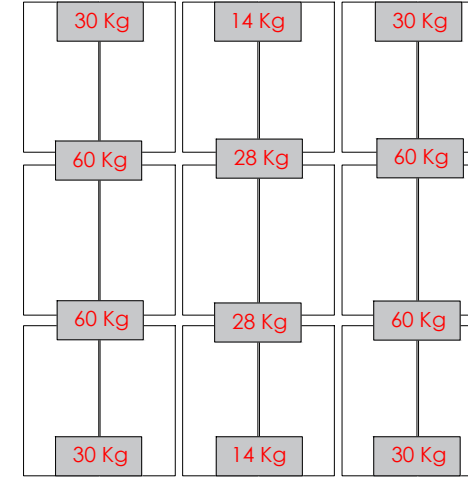

***CON TAPAS LATERALES**

Velocidad: 130 Km/h

Inclinación: 15°

CONTRAPESOS



*Contrapeso necesario para una velocidad de 130Km/h.

*Válido siempre que se mantenga el Kit unido.

*Los lastres del presente plano se han calculado para cubiertas planas de pendiente $\leq 3^\circ$, cuyo coeficiente de rozamiento sea de 0,7.

*La DF deberá comprobar mediante un ensayo in-situ que el coeficiente de fricción es igual o mayor de 0,7. Ver documento "Ensayo de fricción".



1F2M

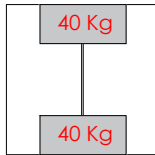

2F4M

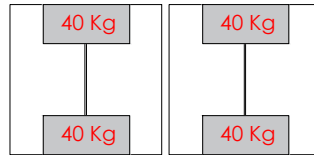

3F6M

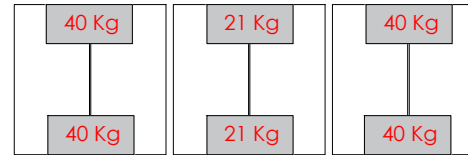

1F4M

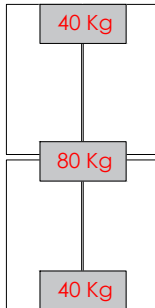

2F8M

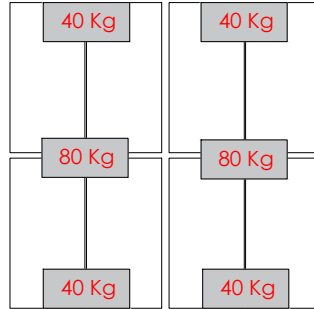

3F12M

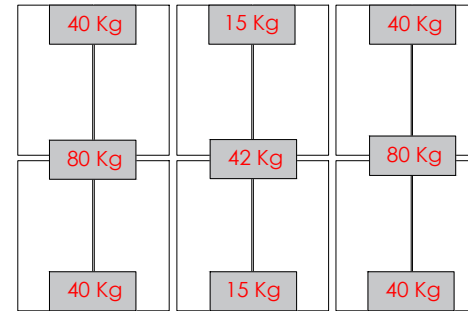

1F6M

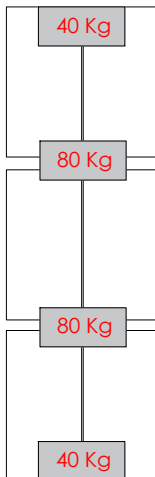

2F12M

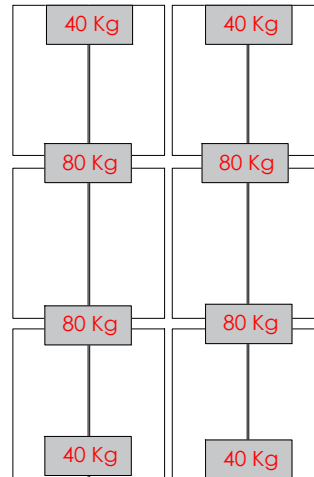

3F18M

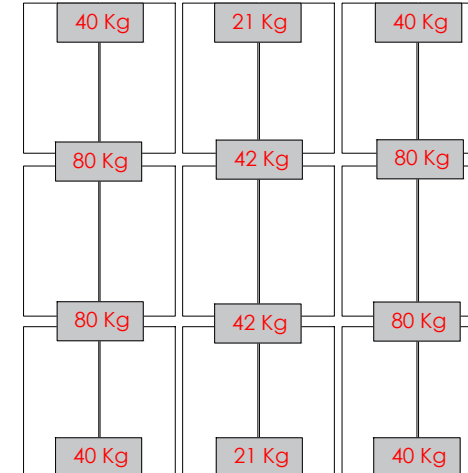

***CON TAPAS LATERALES**

Velocidad: 150 Km/h

Inclinación: 15°

CONTRAPESOS



*Contrapeso necesario para una velocidad de 150Km/h.

*Válido siempre que se mantenga el Kit unido.

*Los lastres del presente plano se han calculado para cubiertas planas de pendiente $\leq 3^\circ$, cuyo coeficiente de rozamiento sea de 0,7.

*La DF deberá comprobar mediante un ensayo in-situ que el coeficiente de fricción es igual o mayor de 0,7. Ver documento "Ensayo de fricción".



1F2M

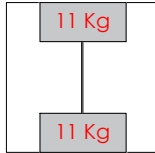

2F4M

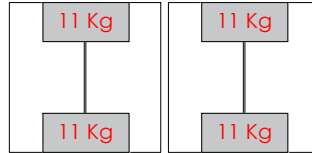

3F6M

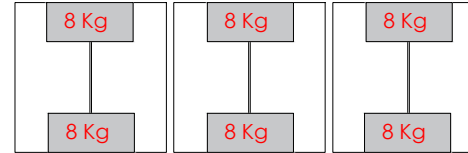

1F4M

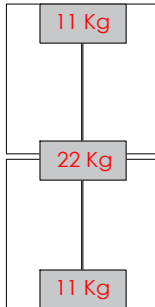

2F8M

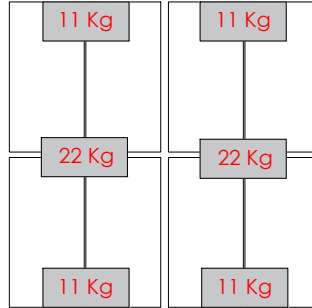

3F12M

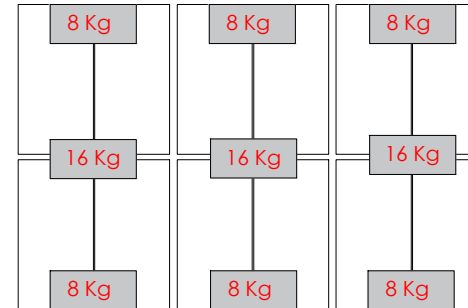

1F6M

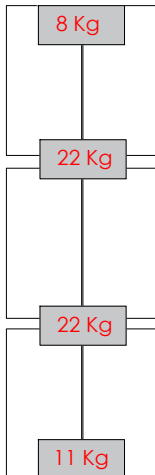

2F12M

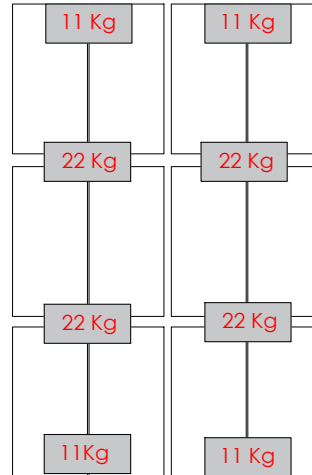

3F18M

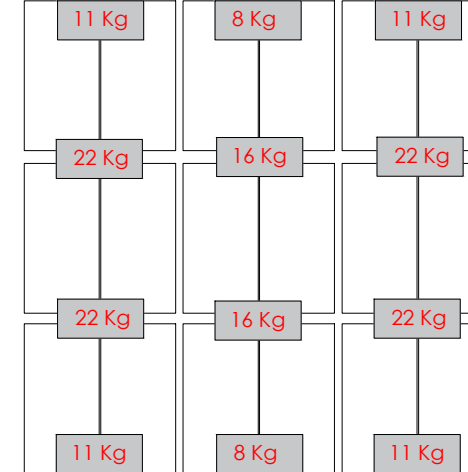

***CON TAPAS LATERALES**

Velocidad: 110 Km/h

Inclinación: 10°

CONTRAPESOS



*Contrapeso necesario para una velocidad de 110Km/h.

*Válido siempre que se mantenga el Kit unido.

*Los lastres del presente plano se han calculado para cubiertas planas de pendiente $\leq 3^\circ$, cuyo coeficiente de rozamiento sea de 0,7.

*La DF deberá comprobar mediante un ensayo in-situ que el coeficiente de fricción es igual o mayor de 0,7. Ver documento "Ensayo de fricción".



1F2M

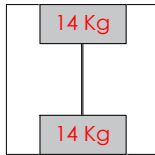

2F4M

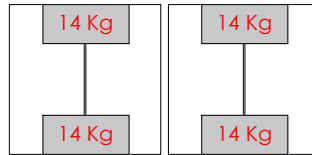

3F6M

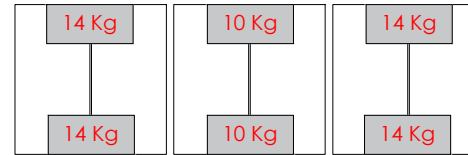

1F4M

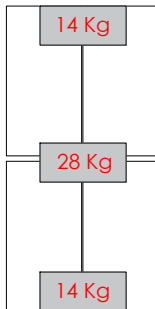

2F8M

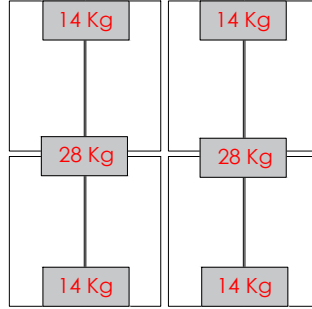

3F12M

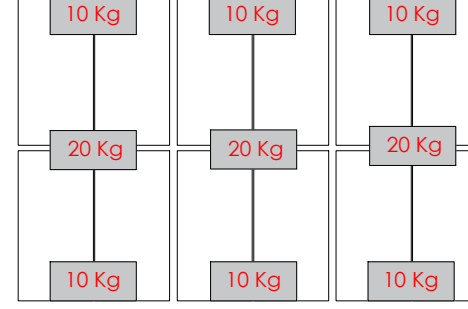

1F6M

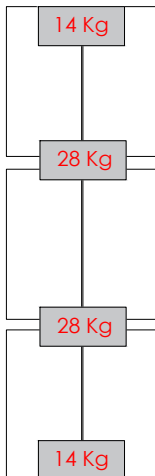

2F12M

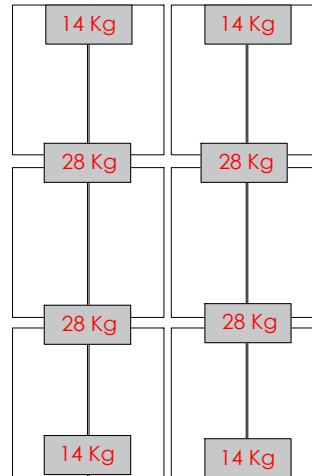

3F18M

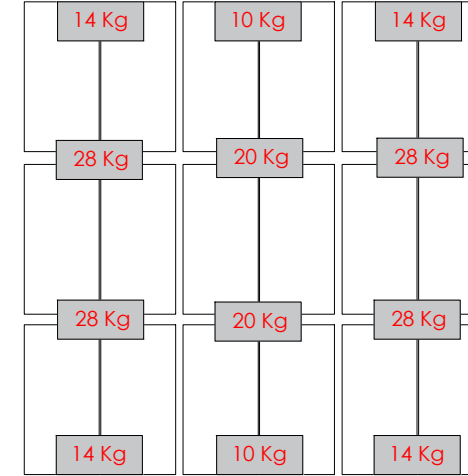

***CON TAPAS LATERALES**

Velocidad: 130 Km/h

Inclinación: 10°

CONTRAPESOS



*Contrapeso necesario para una velocidad de 130Km/h.

*Válido siempre que se mantenga el Kit unido.

*Los lastres del presente plano se han calculado para cubiertas planas de pendiente $\leq 3^\circ$, cuyo coeficiente de rozamiento sea de 0,7.

*La DF deberá comprobar mediante un ensayo in-situ que el coeficiente de fricción es igual o mayor de 0,7. Ver documento "Ensayo de fricción".

1F2M

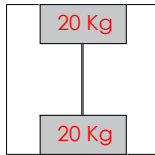

2F4M

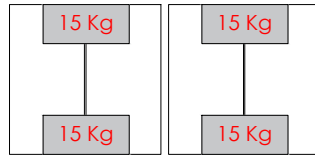

3F6M

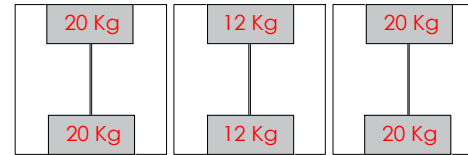

1F4M

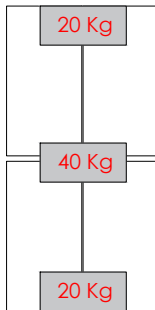

2F8M

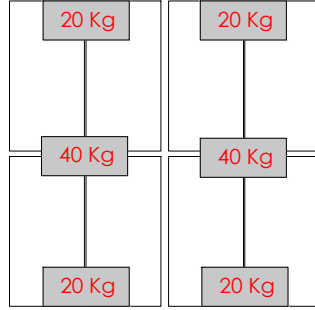

3F12M

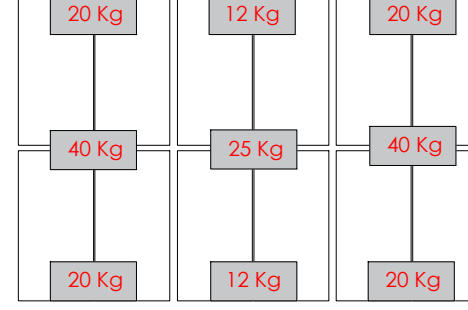

1F6M

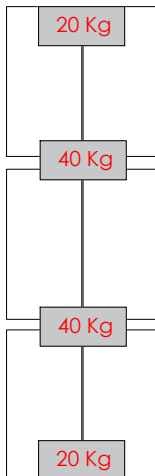

2F12M

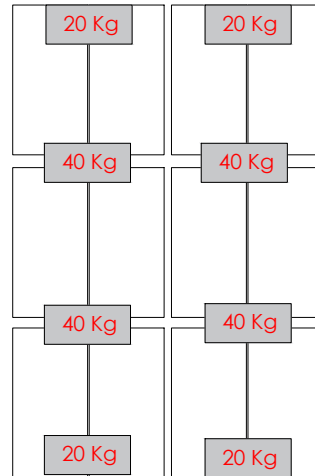

3F18M

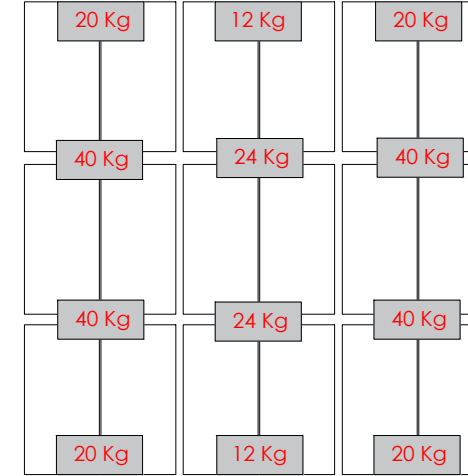

***CON TAPAS LATERALES**

Velocidad: 150 Km/h

Inclinación: 10°

CONTRAPESOS



*Contrapeso necesario para una velocidad de 150Km/h.

*Válido siempre que se mantenga el Kit unido.

*Los lastres del presente plano se han calculado para cubiertas planas de pendiente $\leq 3^\circ$, cuyo coeficiente de rozamiento sea de 0,7.

*La DF deberá comprobar mediante un ensayo in-situ que el coeficiente de fricción es igual o mayor de 0,7. Ver documento "Ensayo de fricción".

