

Despliegue del triángulo preensamblado y de la subestructura portalastre

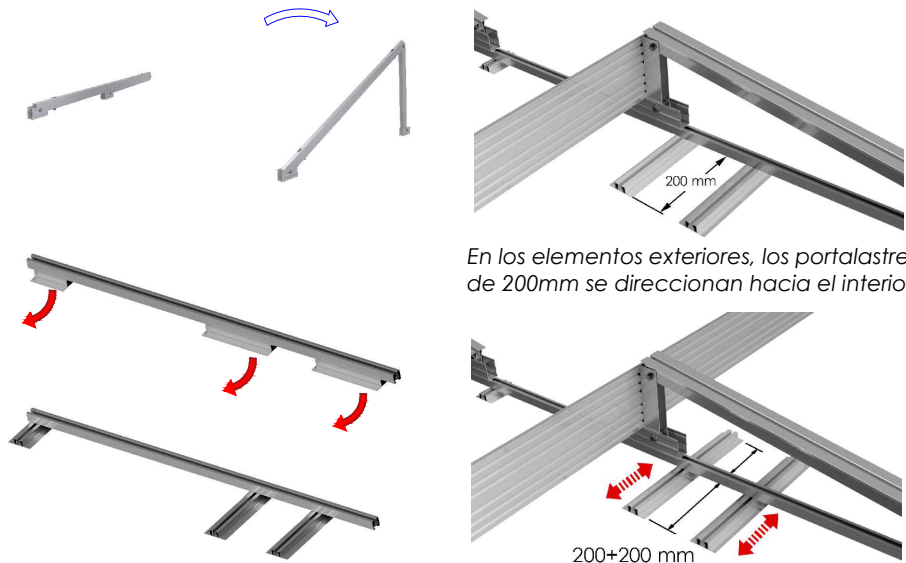

En los elementos exteriores, los portalastres de 200mm se dirigen hacia el interior.

En los elementos interiores, los portalastre de 400mm, se quedan centrados.

Girar los portalastres en función de su posición global en el soporte. (Ver pág. 2)

Anclaje del triángulo a la subestructura y regulación de la separación

¹Base trasera: Aflojar tornillos, retirar tuerca cilíndrica, posicionar triángulo, insertar cilindro y apretar los tornillos.

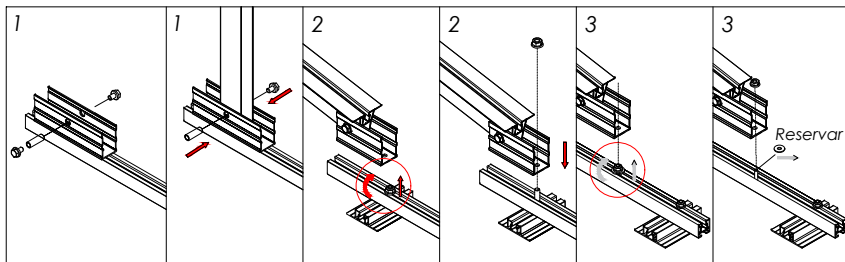

²Base delantera: Aflojar la tuerca de la subestructura, separar las arandelas y la tuerca, alinear el orificio del triángulo con el tornillo de la subestructura, bajar triángulo y ensamblar la unión con las arandelas y tuerca. La posición de la base delantera se puede regular.

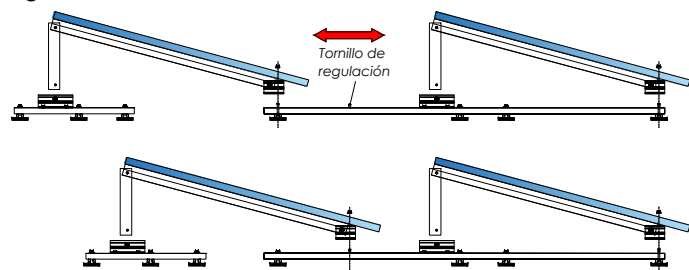

Soporte inclinado lastrado para cubierta plana. Horizontal.

29H

SUNFER

Distancias entre pórticos y emplazamiento de contrapesos

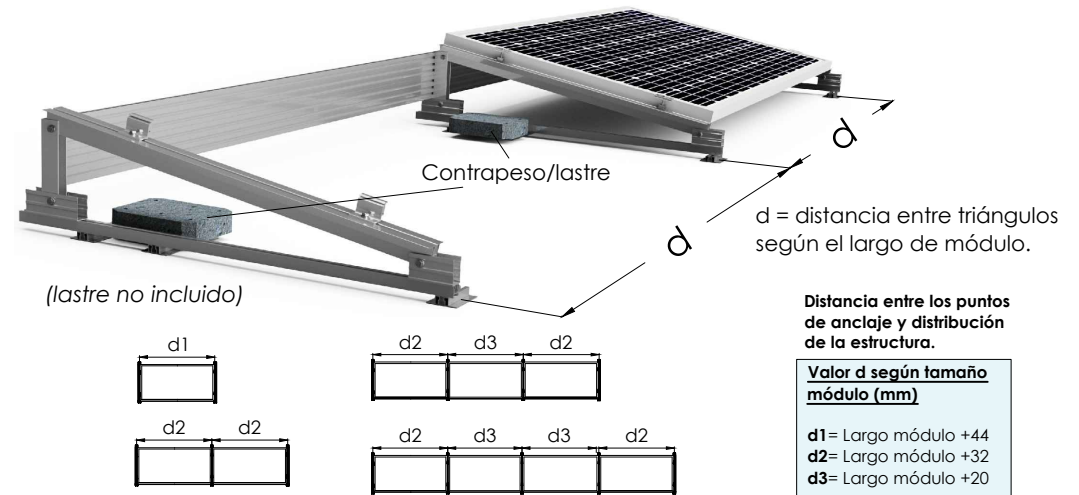

d = distancia entre triángulos según el largo de módulo.

Distancia entre los puntos de anclaje y distribución de la estructura.

Valor d según tamaño módulo (mm)

- d1= Largo módulo +44
- d2= Largo módulo +32
- d3= Largo módulo +20

Montaje módulos

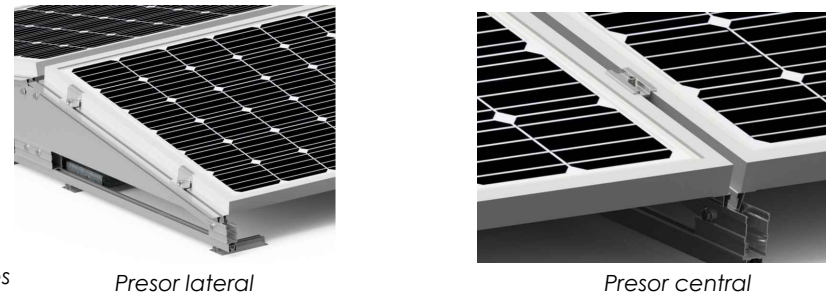

Colocar tapas antiviento



Fijar tapas antiviento al pórtico a través de tornillos autorroscantes suministrados.

Nota: En el caso de que la tapa trasera sea de dos colores la parte gris se colocará en la cara exterior



Tapa trasera

3 tornillos de fijación por triángulo



Tapa lateral (No incluido en el kit)

4 tornillos de fijación por tapa lateral

Tamaño máx. 2279 x 1150



Marcado ES19/86524 CE

PLANO DE MONTAJE

T



Triángulos

6



Elemento 3

2



Elemento 4

1



Elemento 5

2



Elemento 6

1



S10

8



S11

4

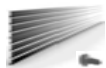

Tapa trasera

4



Tapa lateral

4

*No incluido en el kit



4

Soporte inclinado lastrado para cubierta plana. Horizontal.

29H

SUNFER

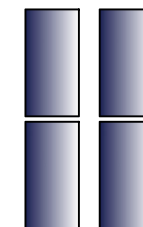
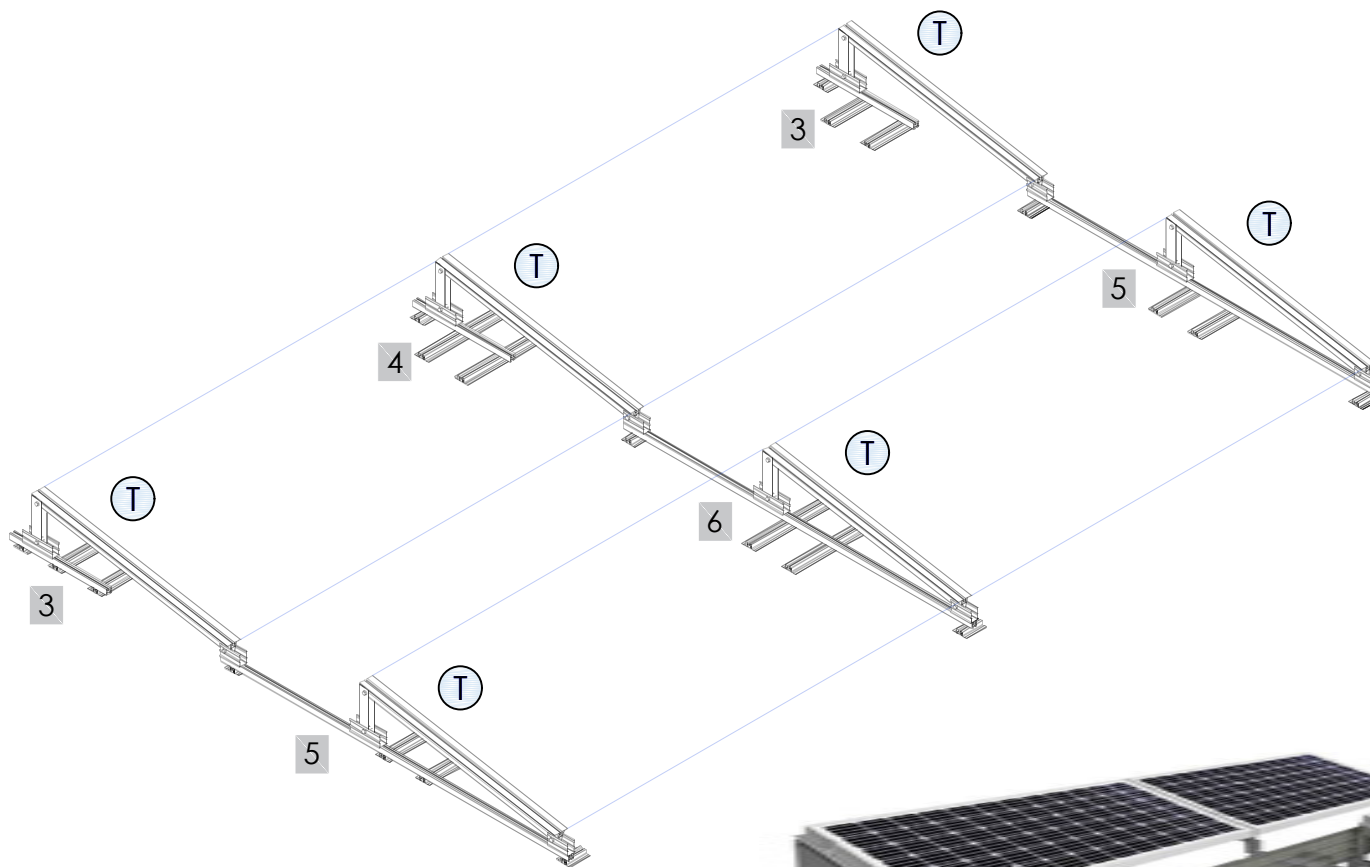
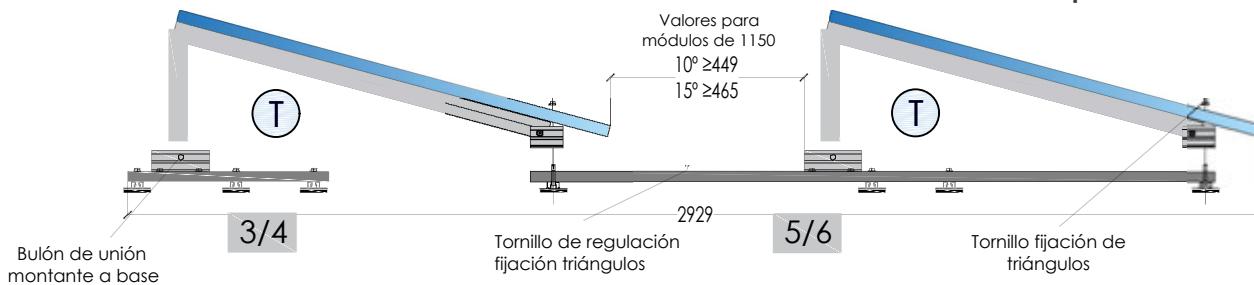

2F4M

CARACTERÍSTICAS DEL MONTAJE



Marcado ES19/86524 CE

2/2

Velocidad: 110 Km/h

Inclinación: 15°



*La validez de la carga se cumple siempre que los bloques estén unidos.

1F1M



1F2M

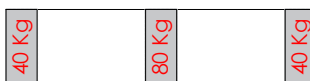

2F2M

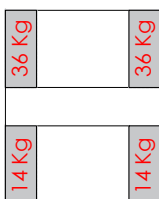

2F4M

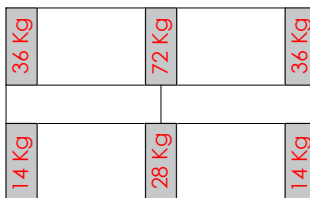

3F3M

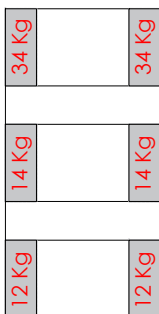

3F6M

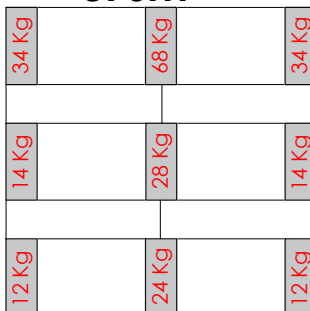

Soporte inclinado lastrado para cubierta plana.
Horizontal.

29H
SUNFER

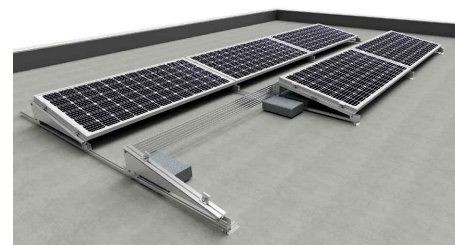

***CON TAPAS LATERALES**

1F3M



2F6M

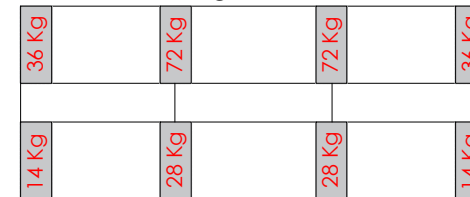

3F9M

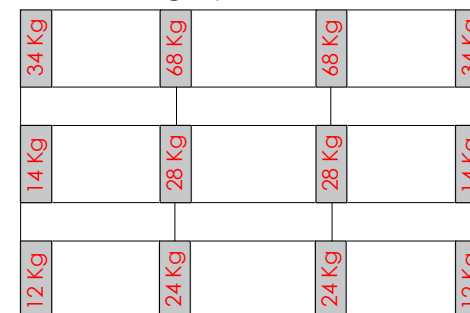

*Contrapeso necesario para una velocidad de 110Km/h.

*Válido siempre que se mantenga el Kit unido.

*Los lastres del presente plano se han calculado para cubiertas planas de pendiente $\leq 3^\circ$, cuyo coeficiente de rozamiento sea de 0,7.

*La DF deberá comprobar mediante un ensayo in-situ que el coeficiente de fricción es igual o mayor de 0,7. Ver documento "Ensayo de fricción".



CONTRAPESOS

Marcado ES19/86524 CE

Velocidad: 130 Km/h

Inclinación: 15°



*La validez de la carga se cumple siempre que los bloques estén unidos.



***CON TAPAS LATERALES**

1F1M



1F2M

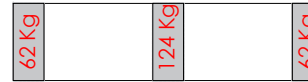

1F3M

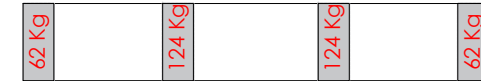

2F2M

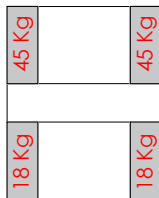

2F4M

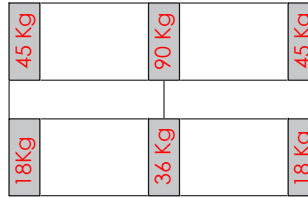

2F6M

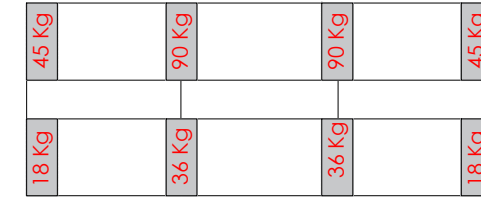

3F3M

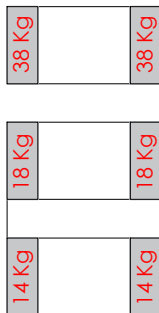

3F6M

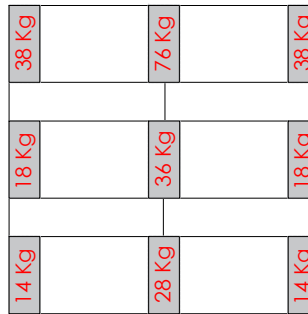

3F9M

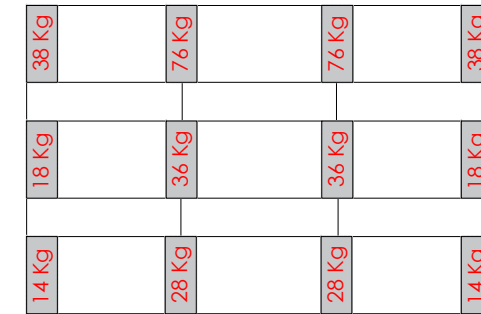

*Contrapeso necesario para una velocidad de 130Km/h.

*Válido siempre que se mantenga el Kit unido.

*Los lastres del presente plano se han calculado para cubiertas planas de pendiente $\leq 3^\circ$, cuyo coeficiente de rozamiento sea de 0,7.

*La DF deberá comprobar mediante un ensayo in-situ que el coeficiente de fricción es igual o mayor de 0,7. Ver documento "Ensayo de fricción".



Velocidad: 150 Km/h

Inclinación: 15°



*La validez de la carga se cumple siempre que los bloques estén unidos.



***CON TAPAS LATERALES**

1F1M



1F2M



1F3M



2F2M

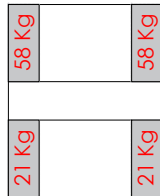

2F4M

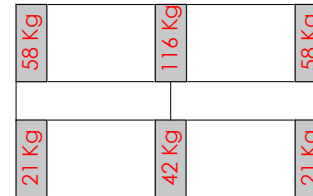

2F6M

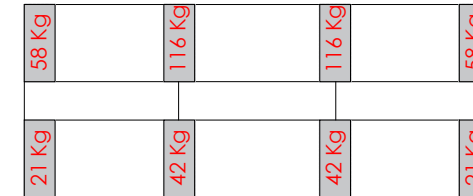

3F3M

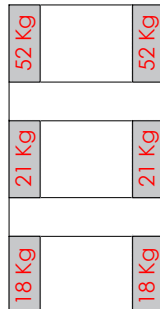

3F6M

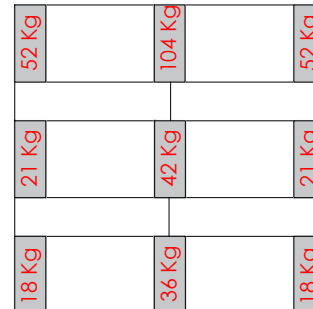

3F9M

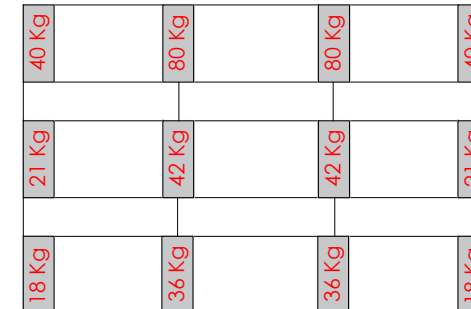

*Contrapeso necesario para una velocidad de 150Km/h.

*Válido siempre que se mantenga el Kit unido.

*Los lastres del presente plano se han calculado para cubiertas planas de pendiente $\leq 3^\circ$, cuyo coeficiente de rozamiento sea de 0,7.

*La DF deberá comprobar mediante un ensayo in-situ que el coeficiente de fricción es igual o mayor de 0,7. Ver documento "Ensayo de fricción".



CONTRAPESOS

Velocidad: 110 Km/h

Inclinación: 10°



*La validez de la carga se cumple siempre que los bloques estén unidos.



***CON TAPAS LATERALES**

CONTRAPESOS

1F1M



1F2M

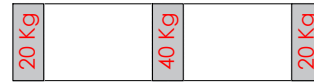

1F3M



2F2M

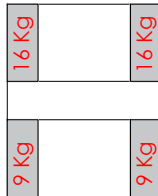

2F4M

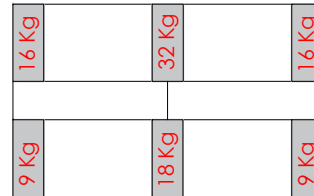

2F6M

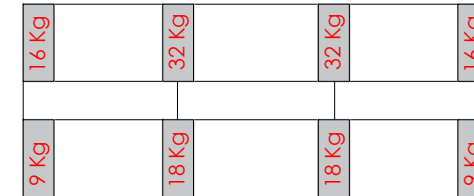

3F3M

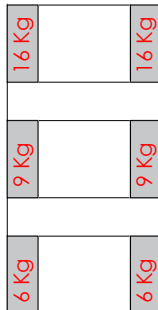

3F6M

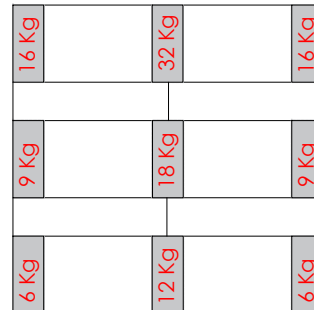

3F9M

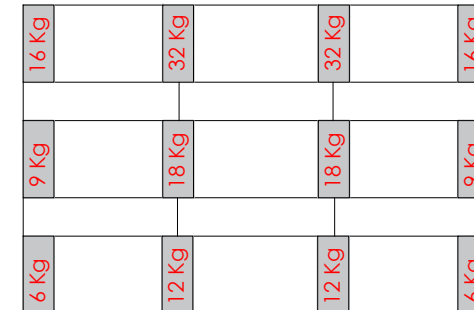

*Contrapeso necesario para una velocidad de 110Km/h.

*Válido siempre que se mantenga el Kit unido.

*Los lastres del presente plano se han calculado para cubiertas planas de pendiente $\leq 3^\circ$, cuyo coeficiente de rozamiento sea de 0,7.

*La DF deberá comprobar mediante un ensayo in-situ que el coeficiente de fricción es igual o mayor de 0,7. Ver documento "Ensayo de fricción".



Velocidad: 130 Km/h

Inclinación: 10°



*La validez de la carga se cumple siempre que los bloques estén unidos.



***CON TAPAS LATERALES**

CONTRAPESOS

1F1M



2F2M

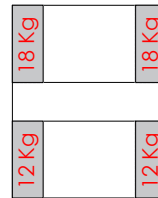

3F3M

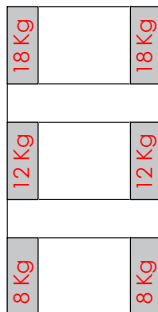

1F2M

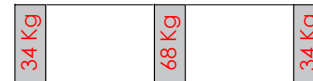

2F4M

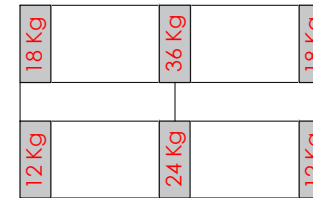

3F6M

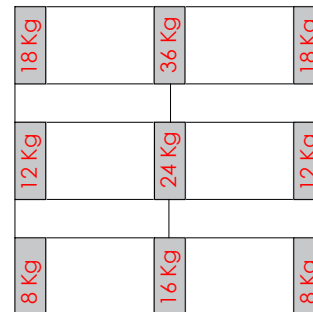

1F3M



2F6M

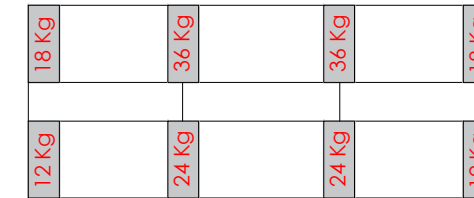

3F9M

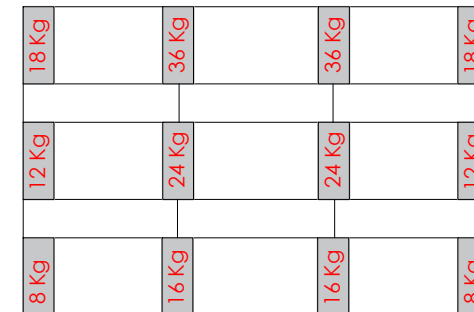

*Contrapeso necesario para una velocidad de 130Km/h.

*Válido siempre que se mantenga el Kit unido.

*Los lastres del presente plano se han calculado para cubiertas planas de pendiente $\leq 3^\circ$, cuyo coeficiente de rozamiento sea de 0,7.

*La DF deberá comprobar mediante un ensayo in-situ que el coeficiente de fricción es igual o mayor de 0,7. Ver documento "Ensayo de fricción".



Velocidad: 150 Km/h

Inclinación: 10°



*La validez de la carga se cumple siempre que los bloques estén unidos.



***CON TAPAS LATERALES**

CONTRAPESOS

1F1M



2F2M

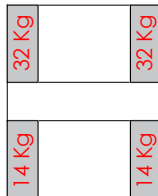

3F3M

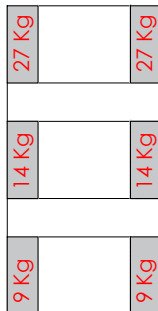

1F2M



2F4M



3F6M

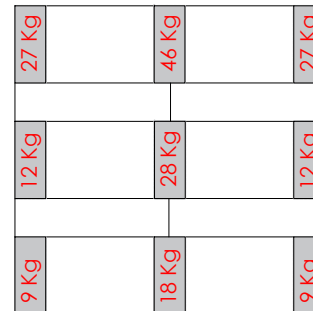

1F3M



2F6M

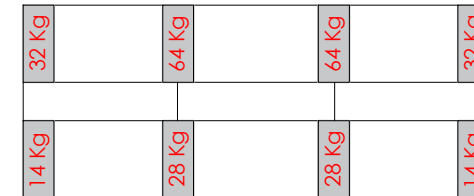

3F9M

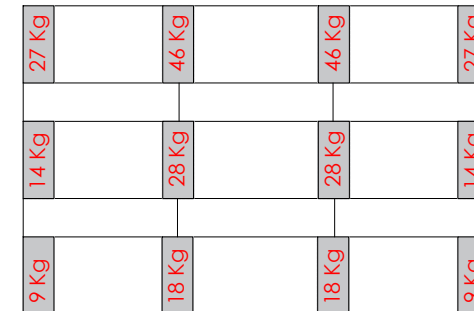

*Contrapeso necesario para una velocidad de 150Km/h.

*Válido siempre que se mantenga el Kit unido.

*Los lastres del presente plano se han calculado para cubiertas planas de pendiente $\leq 3^\circ$, cuyo coeficiente de rozamiento sea de 0,7.

*La DF deberá comprobar mediante un ensayo in-situ que el coeficiente de fricción es igual o mayor de 0,7. Ver documento "Ensayo de fricción".

